



modular storage solutions

im|97 **NEW**

Protezione angoli

La soluzione ideale per la protezione di angoli dei banchi frigoriferi di supermercati e superfici commerciali.

Angle protection

The ideal solution to protect refrigerated counter angles in supermarkets and shopping centers.

**DESIGN INNOVATIVO
INNOVATIVE DESIGN**

**IGIENICO
HYGIENIC**

**ROBUSTO
STRONG**

**SUPERFICI
ARROTONDATE
ROUNDED
SURFACES**



Colori
Colors



Angolo
Angle

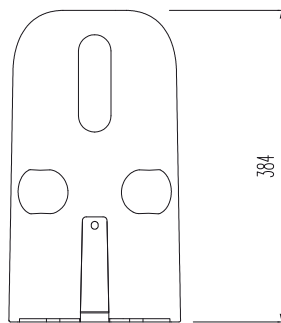

Angolo con protezione
Angle with in-line protection

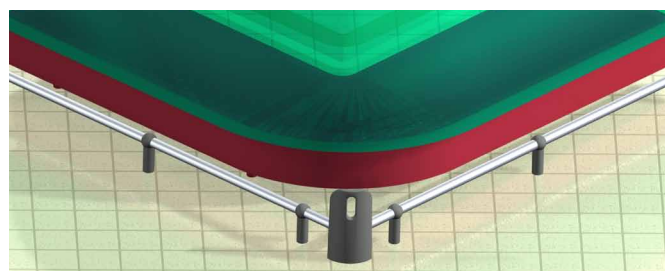
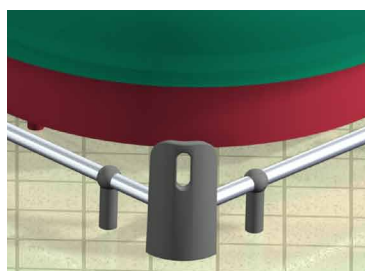
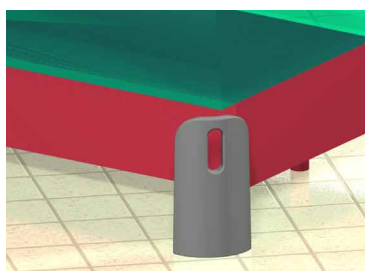
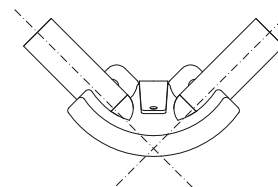
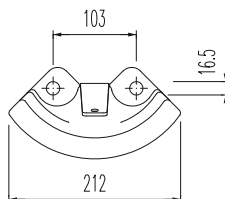
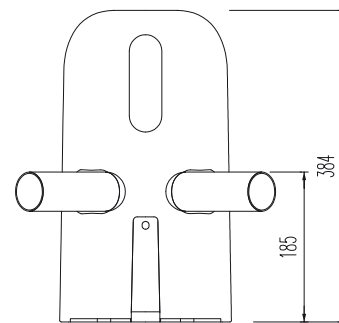

Facile e veloce da montare

L'estrema semplicità di montaggio permette un assemblaggio rapido e facile senza l'ausilio di attrezzi speciali.

Quick and easy to assemble

Extremely easy to assemble without any special tools.

Robusto

Realizzato con materiale plastico antiurto e acciaio inossidabile AISI 304, garantisce una elevata resistenza agli urti.

Strong

Made entirely from shockproof plastic and AISI 304 stainless steel, it guarantees high impact resistance.

Modulare

L'angolo può essere accoppiato con la protezione in linea. (vedi immagine)

Modular

The angle can be combined with the in-line protection. (see image)

Standard di igiene elevato e sicuro

Le superfici lisce e arrotondate garantiscono un elevato standard di igiene.

High standard of hygiene

The smooth and rounded surfaces deliver a high standard of hygiene.

Inalterabile nel tempo

Interamente realizzato con materiale plastico antiurto e acciaio inossidabile AISI 304 garantisce inalterabilità nel tempo contro la corrosione da acqua e umidità.

Durable properties

Made entirely from shockproof plastic and AISI 304 stainless steel, it is guaranteed to offer lasting stability against corrosion by water and moisture.

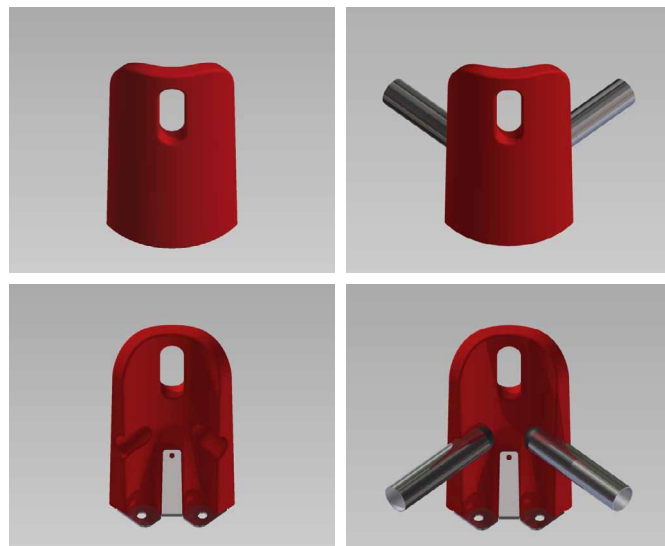

modular storage solutions